

INSTALLATION INSTRUCTIONS

EVOLVE CUBICLES

COMPACT GRADE LAMINATE (CGL) TOILET PARTITIONS

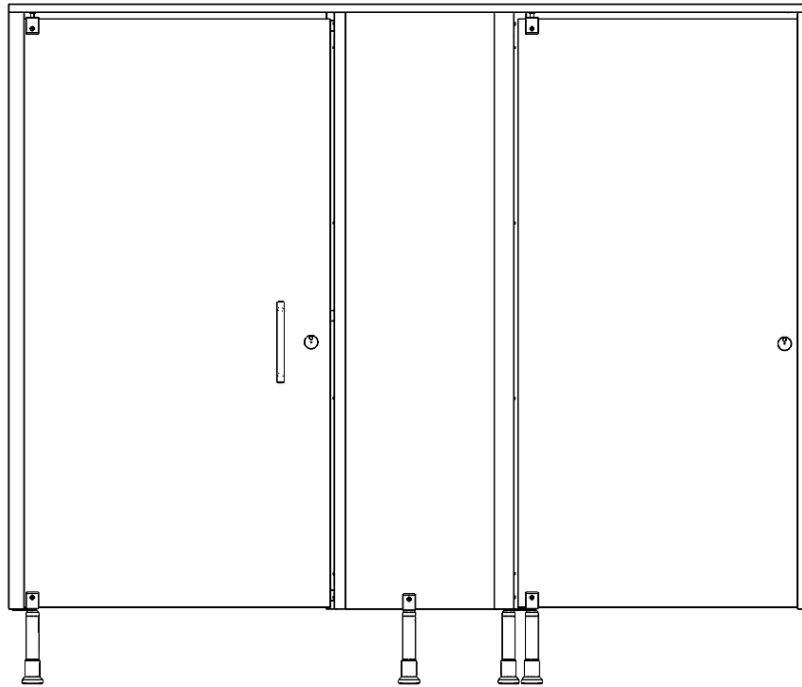

Read these instructions completely and carefully.

IMPORTANT

SAFETY

Use safety glasses and gloves while performing each installation in this booklet. Heavy lifting is required for installation. Do not attempt lifting a divider panel on your own, ask for help.

Evolve is a two person installation.

SKILL LEVEL

Installation of this product requires someone with experience in toilet partition installation, understands ADA code requirements, and is familiar with the installation process.

Proper installation is the responsibility of the installer. Product failures due to improper installation is not covered under Bobrick Warranty.

STORAGE AND HANDLING INFORMATION

Store in a clean, dry area. Do not store outside. Move material to installation area 72 hours before installation. Always store material flat with weight evenly supported. Failure to follow these instructions may result in warped material which is not covered by Bobrick warranty.

Toilet Partition Stacking

Do This

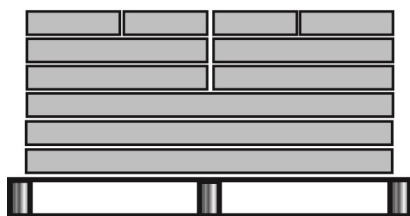

Stack Flat

Don't Do This

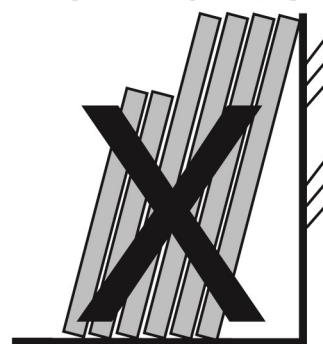

Stack Upright

TABLE OF CONTENTS

TOOLS YOU WILL NEED	Page 4
PRE-INSTALLATION	
Step 1 Verifying Received Order	Page 5
Step 2 Verifying Room Dimensions.....	Page 5
Step 3 Checking Wall Plumb and Floor Slope	Page 6
Step 4 Measuring Stall Centerline.....	Page 6
DIVIDER PANEL, EXTRUSION AND FASCIA PANEL	
Step 5 Wall Channel Bracket Installation	Page 7
Step 6 Preparing for Divider Panel.....	Page 7
Step 7 Setting Divider Panel.....	Page 8
Step 8 Assembling Extrusions.....	Page 8
Step 9 2" Gasket and Center Extrusion Installation.....	Page 9
Step 10 Headrail Pre-Installation.....	Page 9
Step 11 Headrail End Cap Installation	Page 10
Step 12 Fascia Panel Installation	Page 10
Step 13 Leveling Cubicle.....	Page 11
Step 14 Wall Extrusion Installation	Page 11
DOOR AND HARDWARE	
Step 15 Door Installation	Page 12
Step 16 Floor Base Installation	Page 12
Step 17 Securing Headrail Installation	Page 13
Step 18 Door Latch Drilling	Page 14
Step 19 Latch and Indicator Installation	Page 14
Step 20 Door Pull Installation	Page 15
Step 21 Robe Hook Installation.....	Page 15
Step 22 Door Bumper Installation	Page 16
URINAL SCREEN	
Step 23 Urinal Screen Installation	Page 17
Step 24 Finishing and Cleanup	Page 17
CARE AND MAINTENANCE MANUAL	Page 18
ROUTINE INSPECTION	Page 19
TROUBLESHOOTING GUIDE	Page 19
REPLACEMENT PARTS LIST	Page 19
PRODUCT WARRANTY AND LIMITATIONS	Page 19

TOOLS YOU WILL NEED



Safety Glasses



Gloves



2 Self-Leveling Cross Line Laser



Tape Measure and Pencils



Electric and/or Battery-Powered Drill



Complete Set of Drill Bits



9/16" Brad Point Drill Bit
(For Occupancy Latch & Robe Hook)



Complete Set of Screwdrivers



Complete Set of Screw Bits



Pin-Head Torx Screw Driver T2
(Supplied by Bobrick)



Hammer Drill



Ladder



4mm Allen Wrench



Shims



Adjustable Support Jacks



12", 48" and 72" Level



Miter Saw



Rubber Head Mallet



5/32" Masonry Drill Bit



Hammer



4mm Hex Screw Bit



Chalk Line



Carpenters Square



Broom and Dustpan

PRE-INSTALLATION

STEP 1 VERIFYING RECEIVED ORDER

- Open hardware box and locate layout drawings and hardware list. **Fig. 1**
- Verify all components were received by matching ID number on component label to ID number shown on drawing.
- Use the hardware list as a checklist and make sure all hardware is present.
- To check extrusion counts, see layout drawings under Extrusion List for extrusion part number and quantities. **Fig. 2**
- Organize and stage all components and hardware needed for each room.

Fig. 1

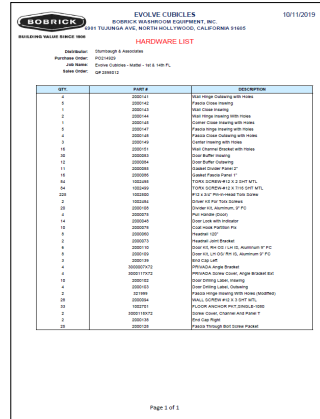
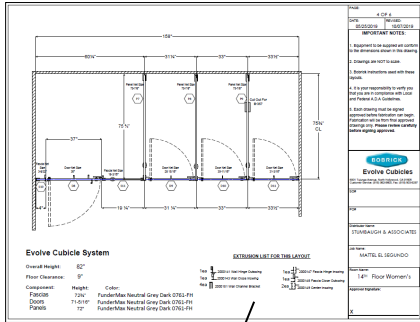

Scan here for
Animated Installation
Videos!



Fig. 2

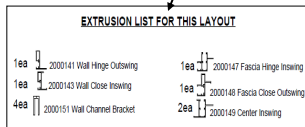

STEP 2 VERIFYING ROOM DIMENSIONS

- Check width of wall at the front centerline. Refer to layout drawing for dimension. *Note: The centerline of each toilet compartment must be measured from the front centerline and not at the back wall.* **Fig. 3**
- Set the laser at the front centerline. Place the chalk line over the laser, mark wall and floor. The chalk line will be used as a guide to set front extrusions. **Fig. 4** If chalk can not be used to mark wall and floor, use a laser device.

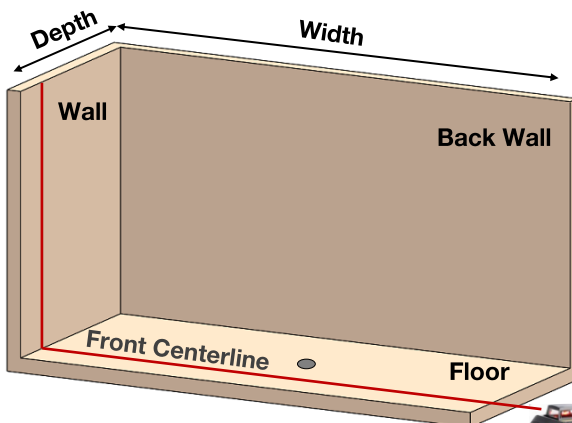

Fig. 3

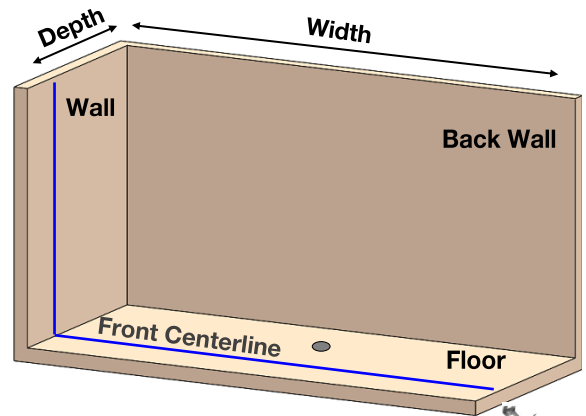

Fig. 4

STEP 3 CHECKING WALL PLUMB AND FLOOR SLOPE

- Check wall plumb using 72" level. If wall is out of plumb, plan on using shims or fillers to fix out of plumb wall. **This step is critical. Fig. 5**
- Check floor slope by measuring the highest and the lowest point of the floor. *Note: Foot pedestal can be adjusted +2".*
- Measure 9"-12" from the front centerline back and make sure floor drain does not interfere. If so, plan on relocating the divider pedestal. **Fig. 6**

Fig. 5

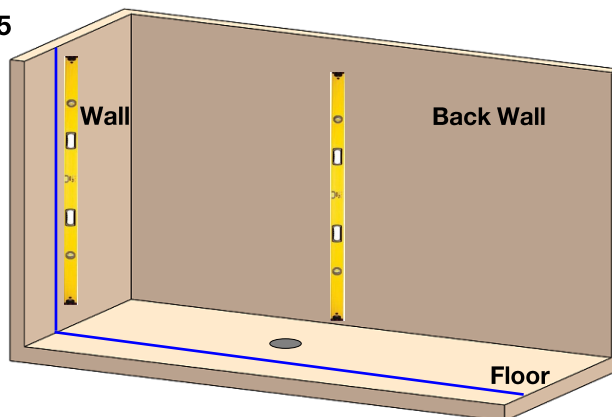
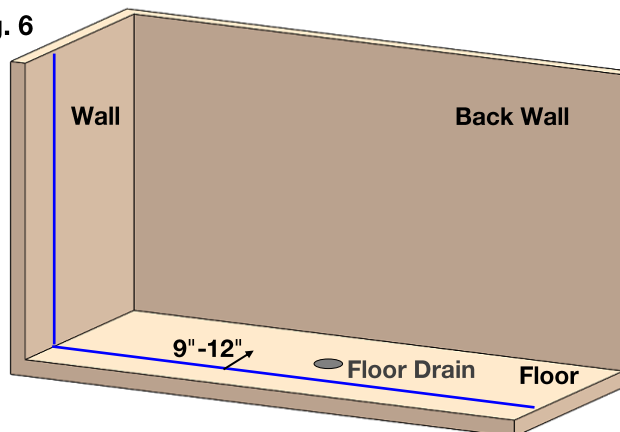

Fig. 6



STEP 4 MEASURING STALL CENTERLINE

- Using a measuring tape, measure wall to centerline of divider panel at the front and mark floor. Refer to layout drawing for centerline dimensions. **Fig. 7**
- Set laser device at the front centerline pointing to back wall. Use a carpenter's square to guide laser device as shown in **Fig. 8**. *Note: Where the laser line appears on the back wall is where the U-channel will be attached to the wall.* This dimension may not be the same as measuring off the side wall to the panel centerline. This will ensure square off the front of the system.

Fig. 7

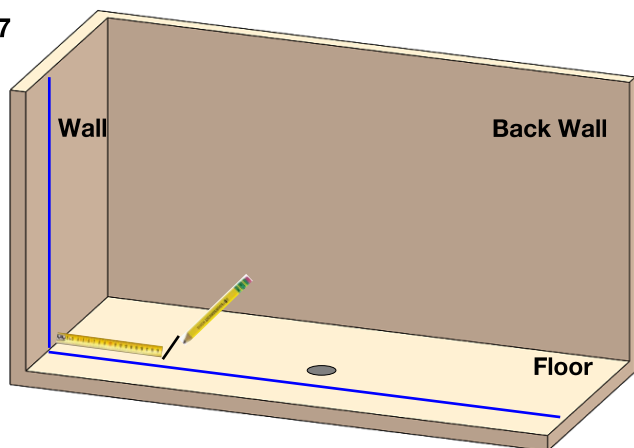
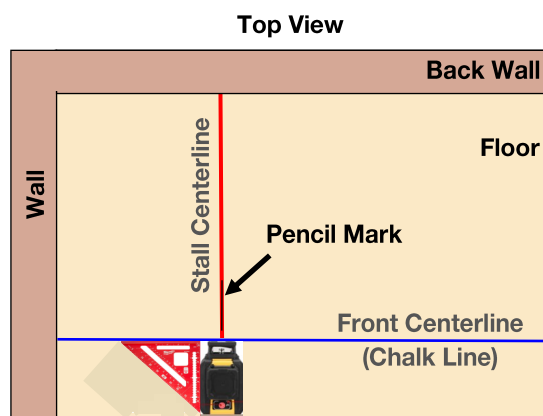
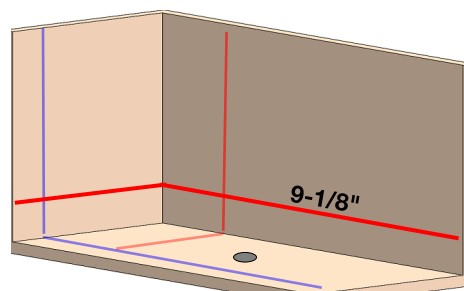

Fig. 8



- Using a secondary laser device, set laser 9-1/8" from the highest point of the floor pointing towards the back wall. **Fig. 9** The horizontal line is where the bottom side of the wall channel will be placed.

Fig. 9



DIVIDER PANEL, EXTRUSION AND FASCIA PANEL

STEP 5 WALL CHANNEL BRACKET INSTALLATION

- Place bottom of Wall Channel on the horizontal laser guide at the back wall. Center each screw hole on the vertical laser guide and mark each screw hole with a pencil. **Fig. 10**
- Drill a 2" deep pilot hole with a #19 drill bit. *Note: If backing is not present, add a plastic anchor (not furnished).* Secure wall channel to wall with #12 x 2" Pin-In-Head Torx Screw (**Part #1002495**).

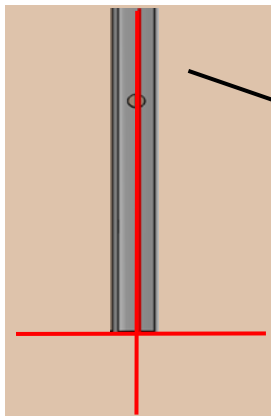
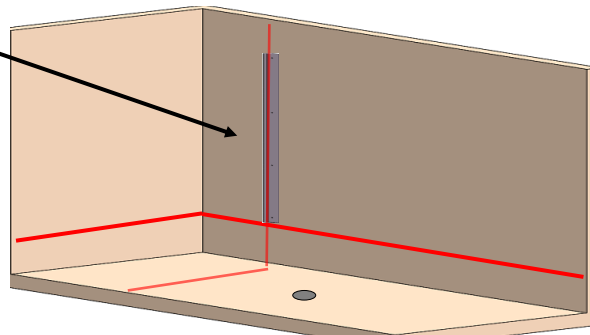

Fig. 10



(#1002495)
#12 x 2"
Pin-In-Head Torx
Screw

Scan here for
Animated Installation
Videos!



- Repeat **Step 4** and **Step 5** for each divider panel.

STEP 6 PREPARING FOR DIVIDER PANEL

- Adjust support jack at 9" high measuring from the floor and set at the back to support the weight of divider panel.
- Slide flange cover up and set pedestal at 9" high and place near the front of floor to support weight of divider panel. **Fig. 11**
- Do not secure threaded base on floor yet.

Fig. 11

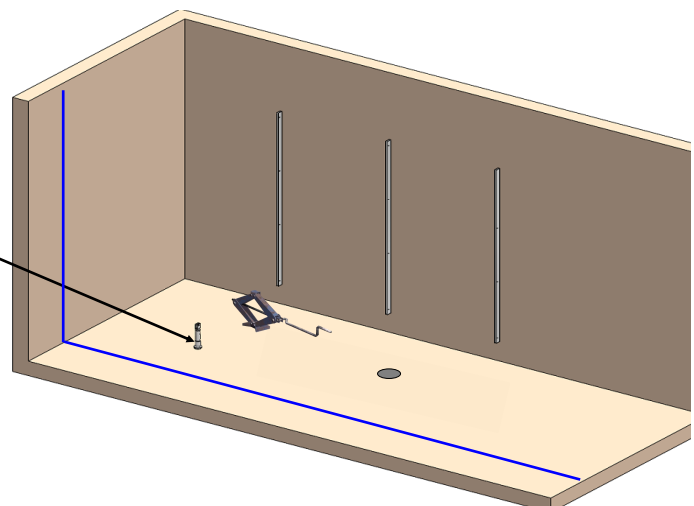
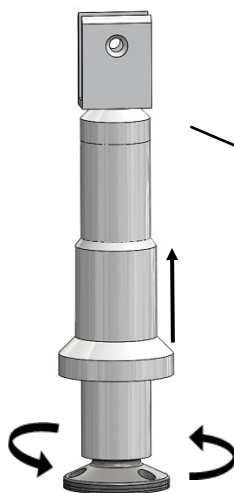

STEP 7 SETTING DIVIDER PANEL

- A. Carefully insert divider panel into wall channel and into U-bracket of divider pedestal. Back side of panel should be resting on support jack.
- B. Adjust divider pedestal up or down by rotating plastic base of the pedestal. Level top and front of divider panel.
Fig. 12
- C. Make sure material sits 1/8" higher than wall channel at the top. **Fig. 13**
- D. Drill top pilot hole using #19 drill bit and secure material to wall channel with #12 x 7/16" Pin-In-Head Torx Screw (**#1002499**). *Note: The top screw will act like a pivot when making adjustments to the front installation.*
- E. Repeat above for each divider panels.

Fig. 12

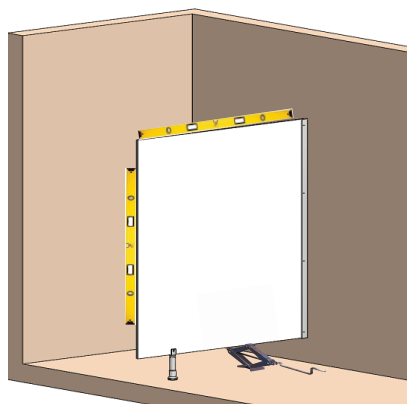
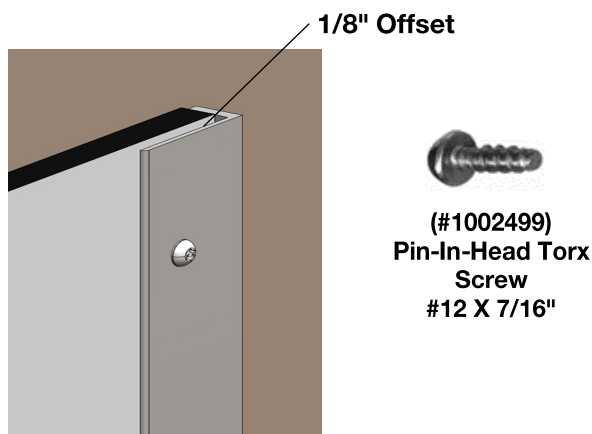

Fig. 13



STEP 8 ASSEMBLING EXTRUSIONS

- A. Locate Pedestal Door Kit Packet and layout drawing. Check door swing on layout drawing, compare door swing to swing type shown on label of Door Kit.
- B. Open Pedestal Door Kit Packet and remove the Headrail L-brackets.
- C. Set L-brackets to all center extrusions by inserting bracket into slotted section top of extrusion. Secure pan head screw using a 4mm hex key.
- D. Headrail L-bracket with plastic cam must be set at the hinging side of extrusion and L-bracket without plastic cam must be set at the keeping side of extrusion. **Fig. 14**
- E. Install door pedestal into hinging side of extrusion by inserting L-bracket into slotted section at the bottom side of extrusion. **Fig. 15** Secure door pedestal to extrusion with pan head screw using a 4mm hex key.
- F. Repeat above steps for each hinging extrusions.

Fig. 14

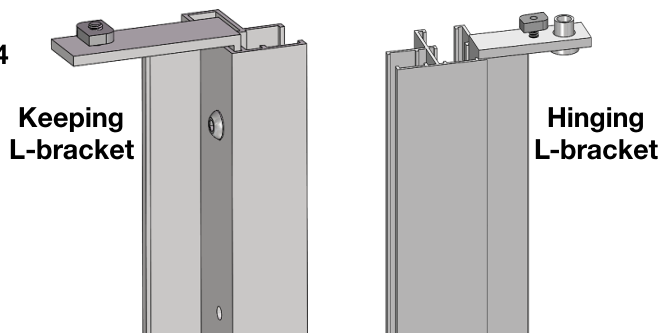
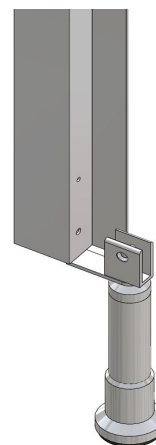
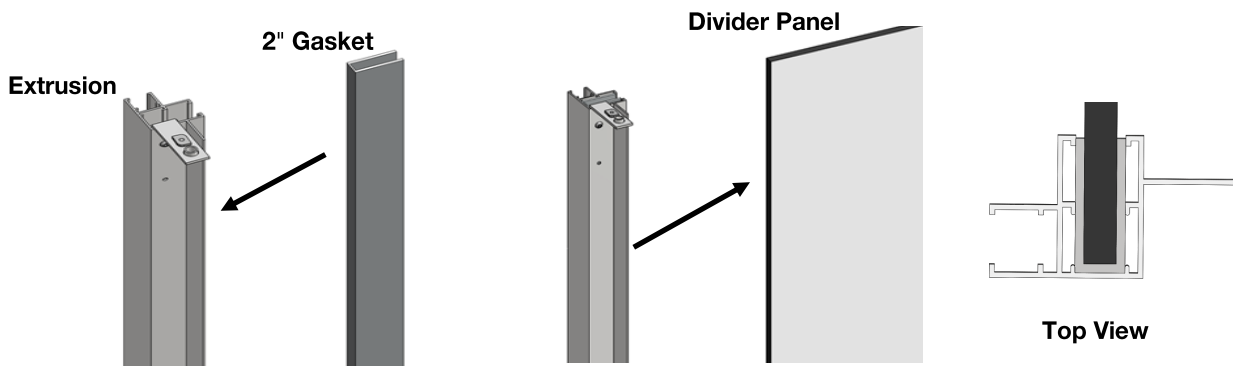

Fig. 15



STEP 9 2" GASKET AND CENTER EXTRUSION INSTALLATION

- A. Check layout drawing to verify correct extrusion is used.
- B. Insert 2" gasket (#2000198) into extrusion. Make sure gasket is completely inserted and sits flush.
- C. Attach extrusion with gasket to front edge of divider panel. Check plumb of extrusion with level.
- D. Using a #19 drill bit, drill 3/4" deep pilot hole through each screw hole of extrusion. Secure extrusion to panel using #12 x 3/4" Pin-In-Head Torx Screw (#1002500). **Caution: Do not drill through extrusion.**
- E. Repeat above process for each center extrusion.



STEP 10 HEADRAIL PRE-INSTALLATION

- A. Check layout drawing to identify ID number of headrail per room. Headrail is pre-cut by the factory to ensure joint is set at center of extrusion.
- B. Position each speed nut parallel with L-bracket and loosen hex screw in speed nut. **Fig. 16**
- C. Place pre-assembled headrail over each L-bracket and press down to snap into place. **Fig. 17**
- D. Temporary secure headrail to L-bracket with 4mm hex bit using a manual driver. The speed nut will change position and lock onto inner groove of headrail. **Fig. 18**

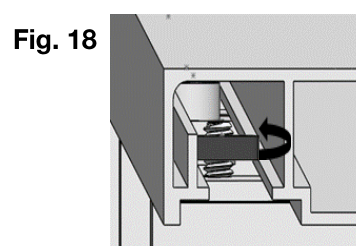
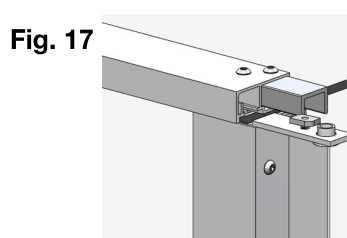
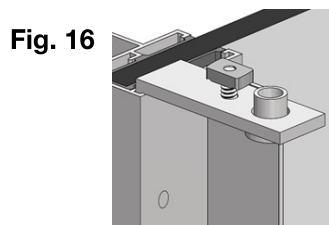

- E. Take dimension from headrail #1 to wall or outer corner and cut headrail #2 to that size. When cutting the headrail make sure the orientation is correct to allow the cut side to go to the wall or outside corner.
- F. Insert headrail #2 into joint bracket and snap into place.
- G. Drill two 3/4" deep pilot holes with #19 drill bit and secure headrail to joint bracket with #12 x 3/4" Pin-In-Head Torx Screw (#1002500). **Fig. 19**
- H. Temporary secure headrail to L-bracket by tightening speed nut.

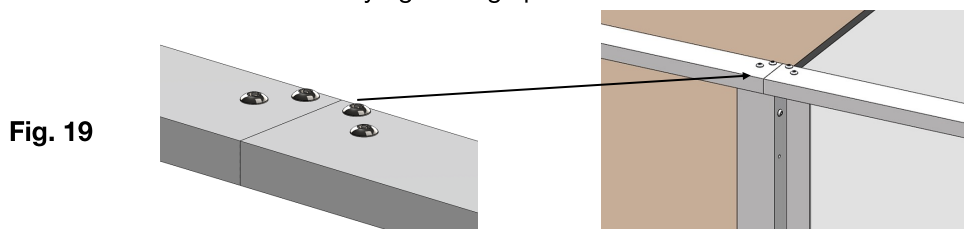

STEP 11 HEADRAIL END CAP INSTALLATION (CORNER LAYOUT)

- A. End cap must be installed where end of headrail is exposed.
- B. Identify if Left or Right End Cap is needed. **Fig. 20**
- C. Position speed nut parallel with headrail, insert end cap into headrail and make sure end cap sits flush with headrail. **Fig. 21**
- D. Secure end cap to headrail using a 4mm hex key to tighten speed nut.

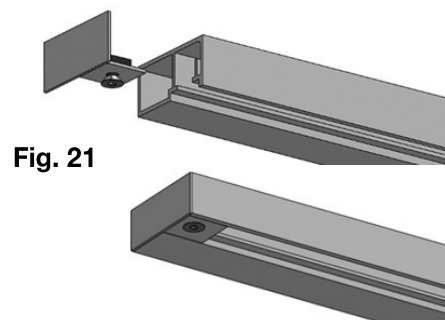
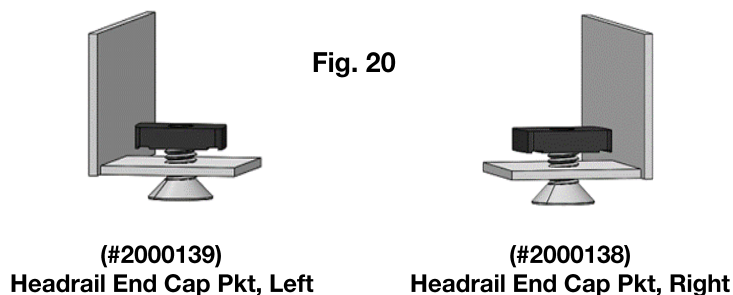

STEP 12 FASCIA PANEL INSTALLATION

- A. Check layout drawing to identify fascia panel and extrusion. Install L-bracket to top of extrusion. Refer to **Step 8**.
- B. Insert 1" gasket (#2000199) into fascia extrusion then attach to edge of fascia panel. *Note: Fascia panel will sit 3/4" higher than extrusion when bottom is flush.*
- C. Using a #19 drill bit, drill pilot holes through each screw hole of extrusion. Do not drill through.
- D. Use #12 x 3/4" Pin-In-Head Torx Screw (#1002500) to secure fascia assembly. **Fig. 22**
- E. Place 1" gasket into extrusion, insert fascia assembly into headrail and slide into extrusion. **Fig. 23**
- F. Temporary secure L-bracket to headrail by tightening speed nut.
- G. Drill pilot holes through each screw hole of extrusion with #19 drill bit and secure with #12 x 3/4" Pin-In-Head Torx Screw (#1002500).

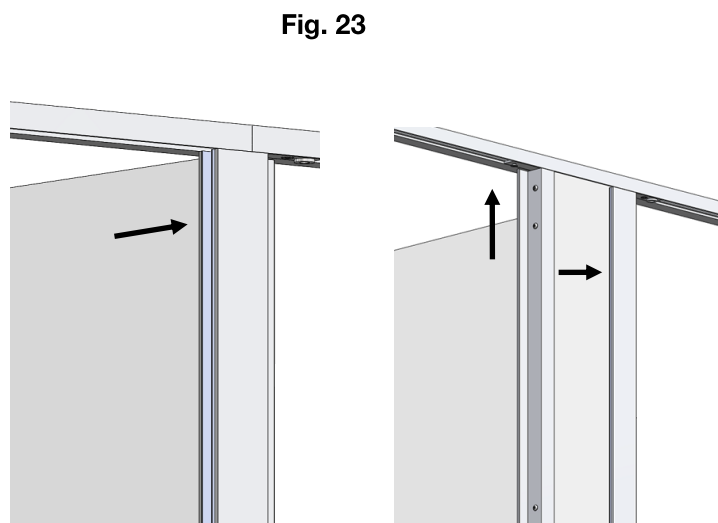
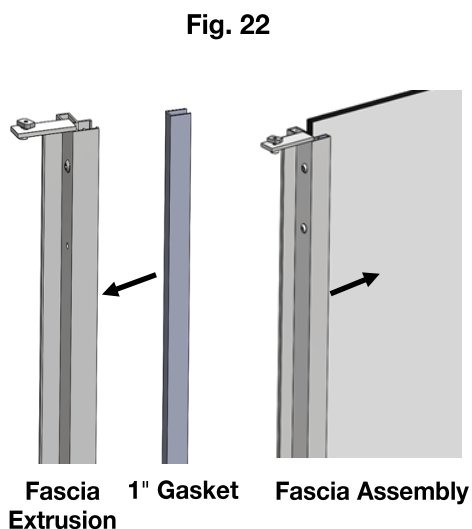

STEP 13 LEVELING CUBICLE

- A. Measuring from the front centerline, position divider pedestal 9"-12" back.
- B. Make sure panel is level at the top and at the front extrusion. **Fig. 24**
- C. Measure stall width at the front (top and bottom) from centerline to centerline of both divider panel. Make sure stall is squared. **Fig. 25** Refer to layout drawing for stall width dimension.
- D. Place 48" level to both center extrusions to ensure fronts are flush. **Fig. 25**
- E. If cubicle is not squared, loosen speed nut on keeping side to adjust the stall and lock into place by tightening the speed nut. Ensure top and front of cubicle is level.
- F. Secure divider panel to wall channel. Refer to **Step 7**.

Fig. 24

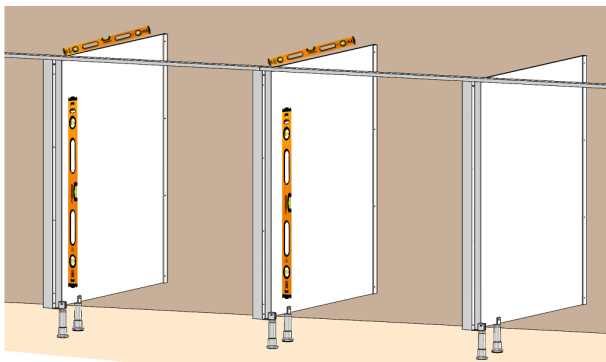
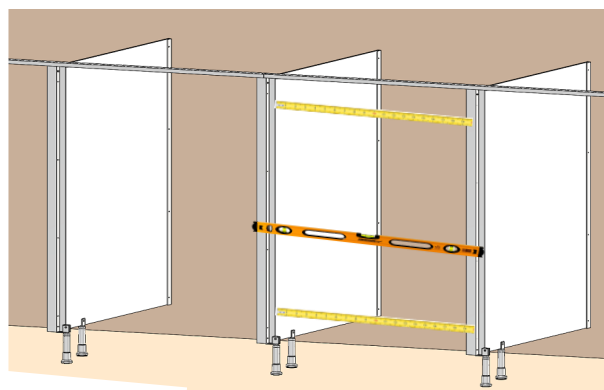
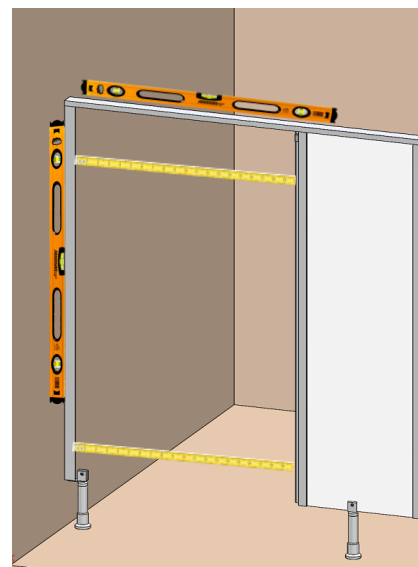

Fig. 25



STEP 14 WALL EXTRUSION INSTALLATION

- A. Locate wall extrusion, install top L-bracket into extrusion and secure with 4mm hex screw.
- B. If hinging a door, install door pedestal to wall extrusion.
- C. Insert extrusion L-bracket into headrail and slide extrusion against the wall. This will self-locate the top attachment point for the extrusion at the wall.
- D. Level the extrusion and mark additional wall attachment points using the extrusion as a guide.
- E. Measure front top and bottom at the front of cubicle to ensure door opening is squared. Level wall extrusion and headrail.
- F. Drill a 3" deep pilot hole with #19 drill bit. *Note: If backing is not present, add a plastic anchor (not furnished).*
- G. Secure extrusion to wall with #12 x 3" Sheet Metal Screw (**#2000094**).



DOOR AND HARDWARE

STEP 15 DOOR INSTALLATION

- A. Install top U-bracket to the top of door, secure with through-bolt included in door kit.
- B. Insert door top U-bracket into cam, slide bottom of door into U-bracket attached to hinge pedestal, align pre-drilled hole with bracket screw hole and secure with countersunk through-bolt.
- C. Install inswing door from inside of toilet compartment and outswing door from outside of toilet compartment.
- D. Make sure the gap on the keeping side is even at the top and bottom. If gap is uneven, loosen speed nut on keeping extrusion, adjust gap as needed and tighten speed nut to hold in place.
- E. **Caution: Door pedestals are designed for either Left-Hand Inswing/Right-Hand Outswing or Right-Hand Inswing/Left-Hand Outswing and has a specific direction of rotation to ensure proper door closure.**
- F. Repeat steps above for each door installation.

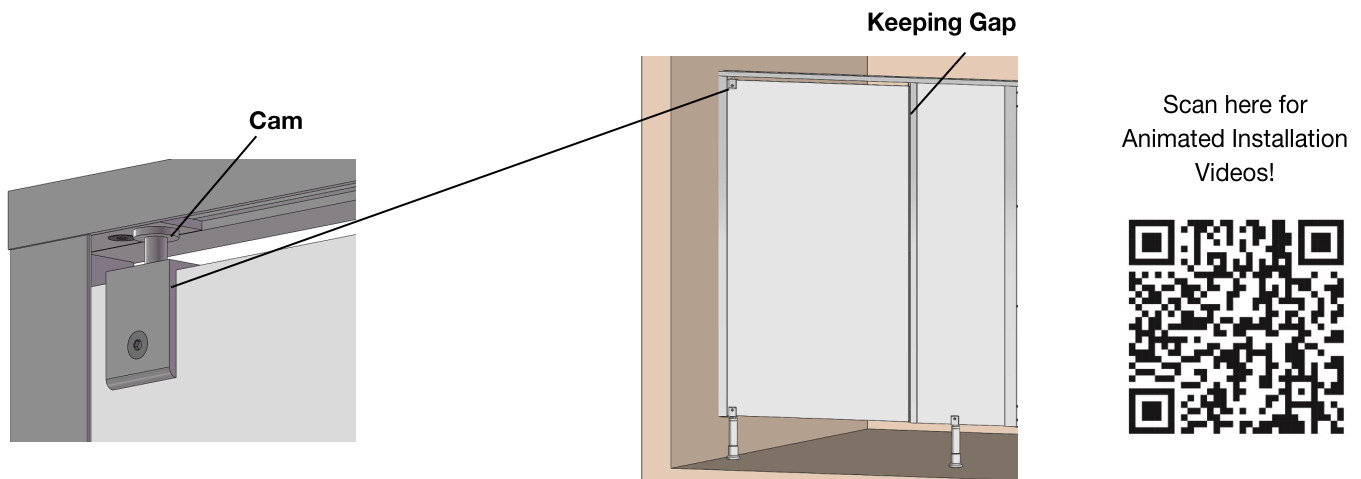

STEP 16 FLOOR BASE INSTALLATION

- A. Slide escutcheon up to access floor base.
- B. Use a 5/32" masonry drill bit, drill a 3" pilot hole into the floor. Use screw holes on base as a guide.
- C. Secure base to floor with 3 concrete screws (#2000187). Slide base cover down and snap into place.
- D. Secure U-bracket to panel by drilling a 9/32" pilot hole through material, use through bolt (included with kit) to lock pedestal to the material, use a 4mm hex bit with a manual screwdriver.
- E. Repeat steps for all pedestals.

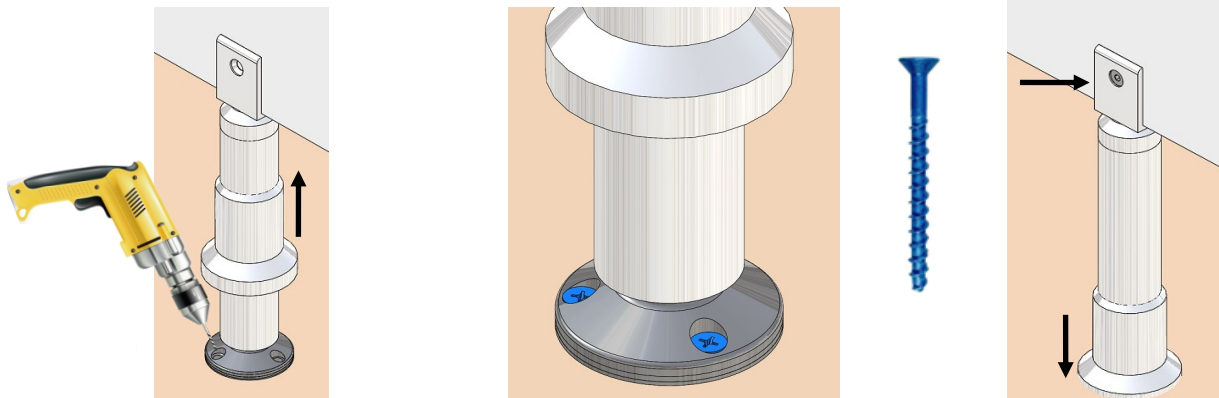

STEP 17 SECURING HEADRAIL INSTALLATION

- A. Where each hinging L-bracket is located, measure 5/8" at the top of the headrail from the front and mark the headrail. **Fig. 26**
- B. Drill a 1/4" pilot hole drilling through the top hinging L-bracket. **Fig. 26**
- C. Secure installation with **(#2000128)** Fascia Through-Bolt Screw Packet. **Fig. 27**

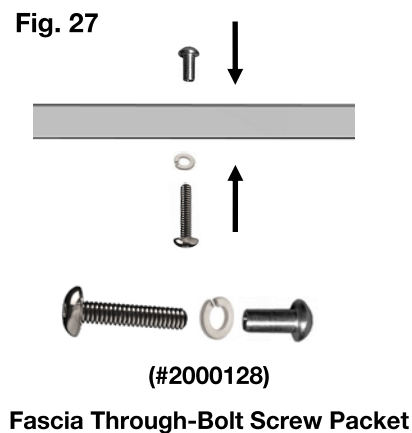
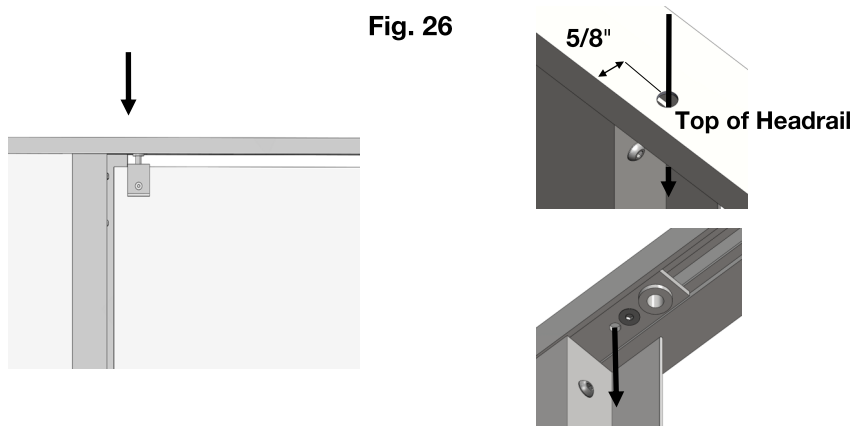

- D. Drill a 3/16" pilot-hole 3/4" deep through top of headrail to top edge of fascia panel.
- E. Secure headrail to top edge of fascia panel with #12 x 3/4" Pin-In-Head Torx Screw **(#1002500)**.

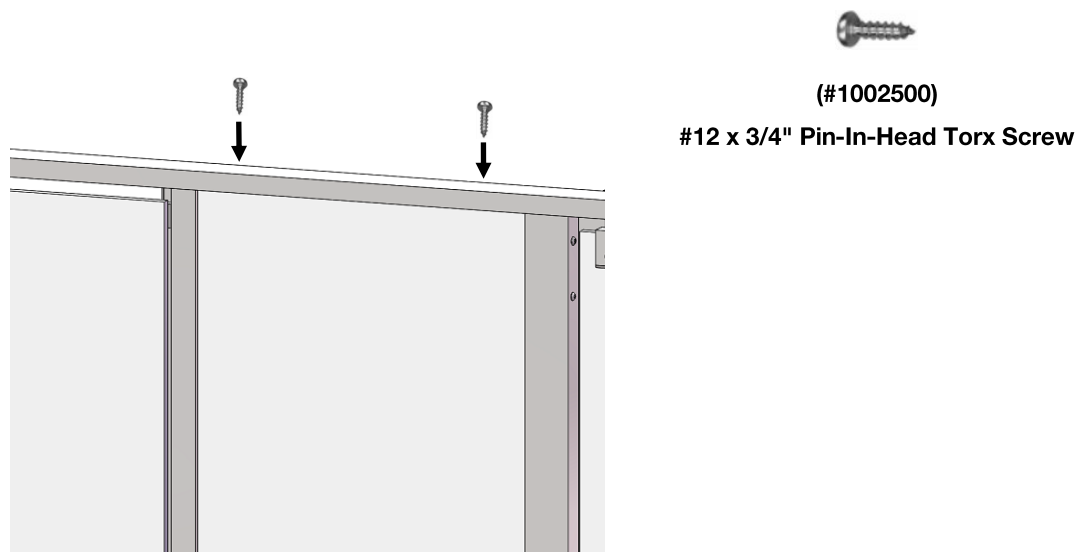

- F. *Note: Screws are not required for a fascia panel less than 12" wide. Fascia panel between 12" to 60" wide, require two screws. Fascia panel over 60" wide, require three screws.*

STEP 18 DOOR LATCH DRILLING

- Measure 31-3/4" from bottom edge of door or 41" from finish floor and mark centerline of where label will be placed.
- Peel off the label and line up the centerline on the label to marked centerline on door. *Note: Vertical line on label must be set from edge of keeping extrusion.*
- Drill 1/4" pilot hole through door center of each hole shown on the label, then remove label.
- Drill center pilot using a 9/16" Brad Point Drill Bit
- Note: Drilling label is included in hardware box for each door. Be sure to read instructions on label before drilling.*

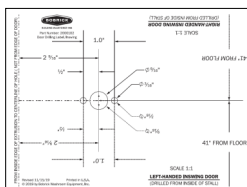

(#2000102)
Door Drilling Label, Inswing

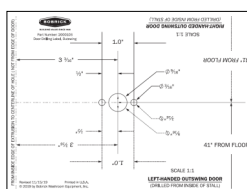

(#2000103)
Door Drilling Label, Outswing

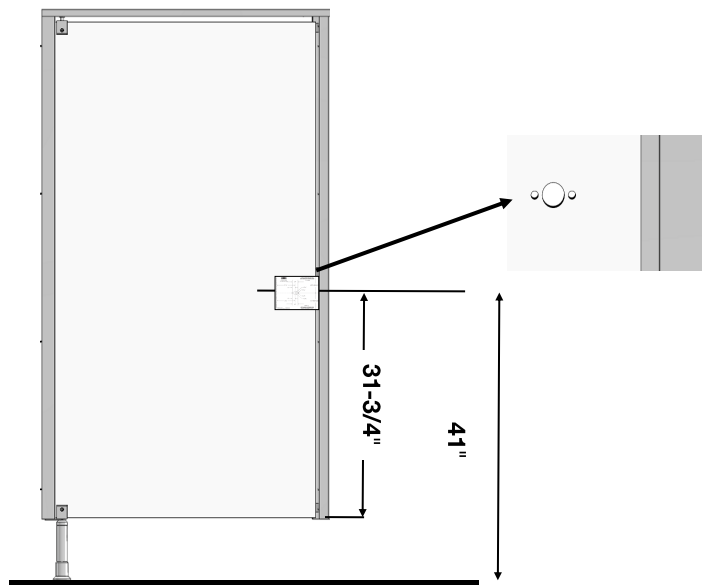

STEP 19 LATCH AND INDICATOR INSTALLATION

- Insert the Latch Handle with Latch Flange through 9/16" pilot hole and position the Indicator Spacer on the outside surface of door.
- Secure assembly using Latch Mounting Screws and Latch Threaded Pin.
- Snap on Indicator Color Disc onto latch post. Install Indicator Cover over color disc and secure assembly with small screw.
- Repeat above steps for each latch installation.

If threaded pin is set on the right, latch will turn clockwise, if set on the left, latch will turn counterclockwise.

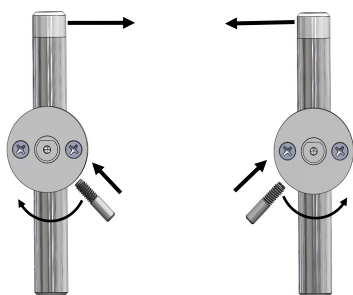

Facing Outside Of Stall

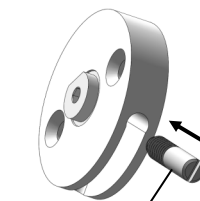
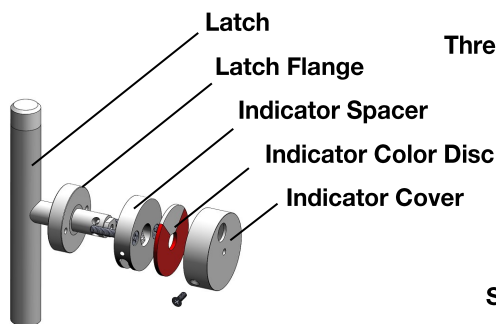

Threaded Pin

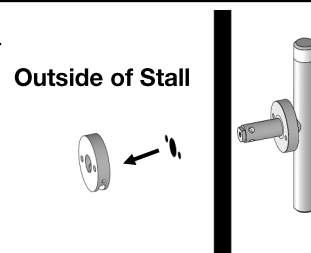

Outside of Stall

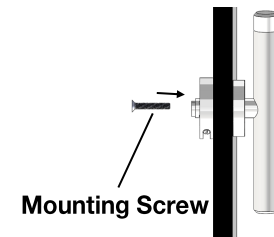

Mounting Screw

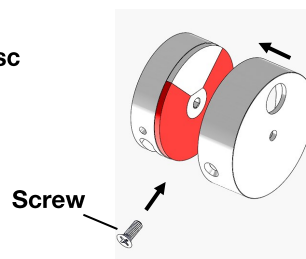

Screw

STEP 20 DOOR PULL INSTALLATION

- A. *Note: Verify local ADA code for pull handle height requirements.*
- B. Remove Threaded Post from assembly. Position the Pull Handle Male on the outside surface of door measuring 4" from centerline of Door Latch to centerline of Door Pull.
- C. Use a small level to ensure Door Pull is straight. Mark around the top and bottom post and draw a dot with an X center of circle.
- D. Drill a 1/4" pilot hole center of each marked circle.
- E. Insert the Threaded Post through the pilot hole and screw into Pull Handle Female assembly. Re-install the Pull Handle Male and secure top and bottom screws with hex key.

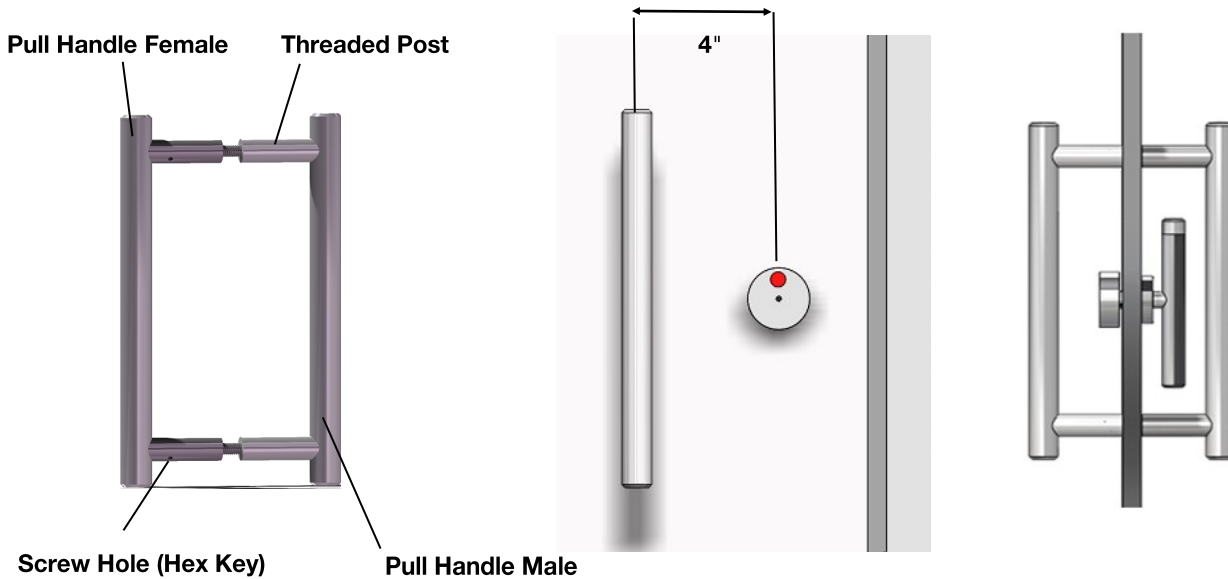

STEP 21 ROBE HOOK INSTALLATION

- A. Identify location of robe hook. *Note: Robe hook should be installed on divider panel to prevent door from making contact with panel.*
- B. Use 1/2" Brad Point Drill Bit and drill through 1/2" material.
- C. Remove button nut from robe hook, insert threaded side of robe hook through 1/2" pilot hole and secure robe hook with button nut. **Fig. 28**
- D. Make sure the pin on robe hook is facing up.

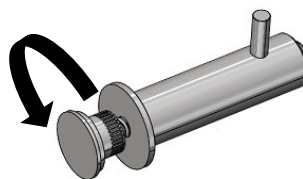
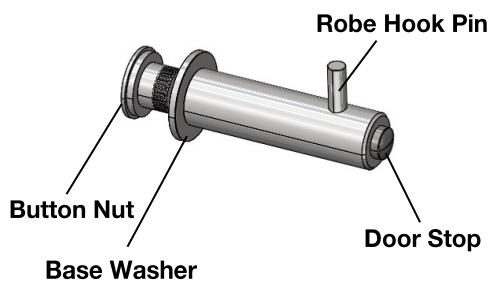
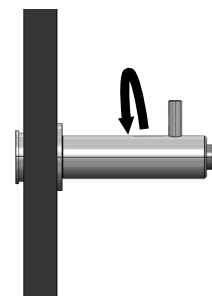

Fig. 28



STEP 22 DOOR BUMPER INSTALLATION

- A. Each keeping extrusion requires 3 bumpers: top, center, and bottom. Refer to diagram below for dimensions.
- B. Remove any debris and oils from keeping extrusion and wipe clean.
- C. Peel off plastic film from bumper and apply to keeping extrusion.
- D. Make sure to use correct door bumper based on door swing.



(#2000083)
Inswing Door Bumper

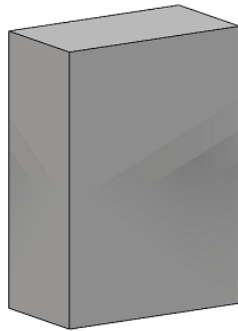

(#2000084)
Outswing Door Bumper

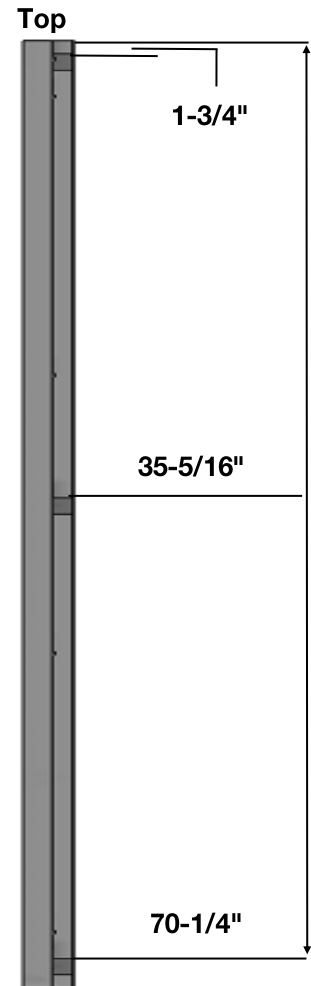

URINAL SCREEN

STEP 23 URINAL SCREEN INSTALLATION

- A. Check wall plumb using 72" level. If wall is out of plumb, plan on using shims or fillers to fix out of plumb wall.
- B. Measure the overall depth from the back wall to the front. *Refer to layout drawing for depth dimension.* Use a chalk line or laser device to mark the overall depth on the floor. **Fig. 29**

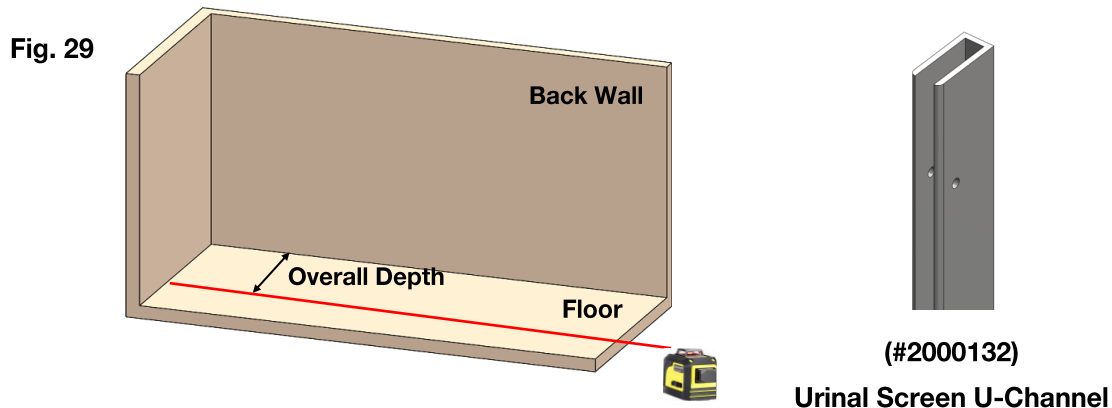

- C. Repeat **Step 4** and **Step 5** for Urinal Screen U-Channel (#2000132) installation.
- D. Repeat **Step 6** for urinal screen set up.
- E. Set divider pedestal 4" to 6" measuring from the front of the urinal screen back. Level the urinal screen at the front and at the top. **Fig. 30**
- F. Using a #19 drill bit, drill a pilot hole through each screw hole of wall channel. *Note: Drill through 1/2" material.*
- G. Secure material to wall channel with Through-Bolt (#2000128). **Fig. 31**
- H. Repeat **Step 16** to secure pedestal to floor and to material.



(#2000128)

Through-Bolt Screw Packet

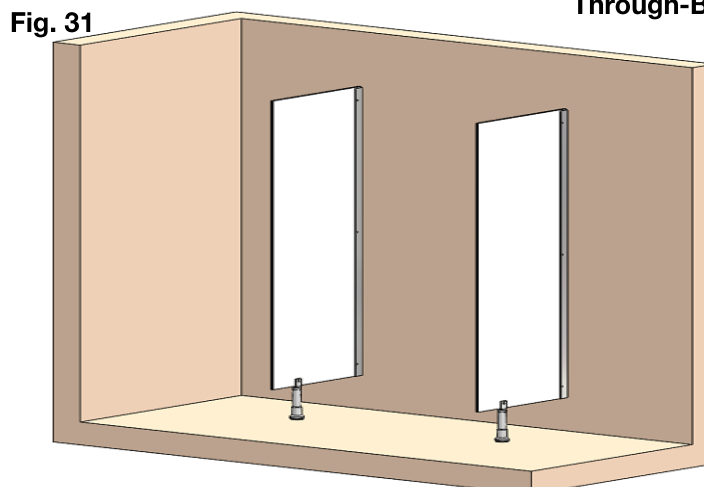
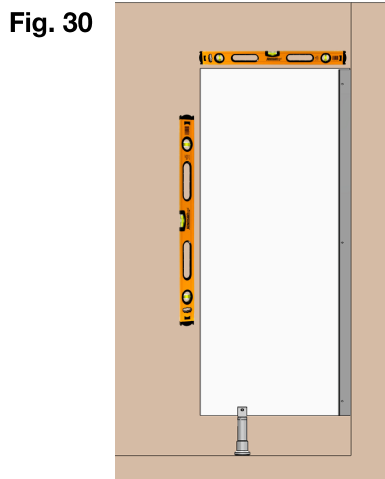

STEP 24 FINISHING AND CLEANUP

- A. Remove any exposed labels from the components of toilet compartments.
- B. Clean surfaces as needed. Refer to **Care and Maintenance Manual** for proper cleaning techniques.

CARE AND MAINTENANCE MANUAL

GENERAL INFORMATION

This manual is intended to provide guidance to the facilities maintenance personnel to properly care and maintain Evolve Cubicle system. It is very important to read and follow cleaning and maintenance guidelines in this manual to help expand the life of the Cubicles, prevent damage to the product during normal use, and ensure a safe operating environment for the patrons.

MAINTENANCE

- Given proper care, toilet partitions doors, panels and fascia surfaces will retain their appearance for years. Periodic cleaning with a furniture polish is usually all that is required to keep them looking new.
- Avoid any abrasive contact with the cubicles while doing floor maintenance. Abrasive contact may cause chipping and damage to the cubicle component.
- Most stains can be completely removed with the cleaning methods listed. However, if the surface is scratched or badly worn, stains may be more difficult to remove and some may leave a ghosting effect.
- The following substances should not be placed on any surface and any inadvertent spills must be wiped off immediately and rinsed thoroughly to avoid serious damage: Sulfuric and nitric acids, hydrochloric and oxalic acids (used in liquid toilet bowl cleaners), bleaches, sodium hydroxide (used in lye and oven cleaners) and sodium hypo chlorite (used in laundry bleach).
- Abrasive pads, scouring powders or cleansers may permanently damage the laminate surface making it susceptible to staining.
- Harsh chemicals: Harsh chemicals such as oven cleaner, toilet cleaner or drain cleaner will etch and discolor the decorative surface. Compact Laminates are not designed to resist continual contact with these chemicals. If any of these products spill over the surface remove immediately, rinse thoroughly and wipe dry.

CLEANING GUIDELINES FOR MATERIAL

To clean soils from surface of door, fascia panel, divider panel, and urinal screen follow guidelines in the table below.

TYPE OF SOIL	CLEANING AGENT	METHOD OF APPLICATION
Dirt, smudges and fingerprints	Mild cleaning solution.	Wipe off soil using a cloth or sponge for smooth surfaces and a soft brush for textured surfaces. Rinse and dry.
Greasy soil, lipstick, crayon and oil	General purpose cleaner or mild degreaser.	Gently rub off soil using a cloth, sponge or soft bristle brush moistened in the cleaning agent. Rinse and dry.
Scaling or water marks	Bathroom cleaners containing phosphoric acid or acetic acids.	Gently rub off soil using a cloth, sponge or soft bristle brush moistened in the cleaning agent. Rinse and dry.
Graffiti or sticky residue	Bobrick Graffiti Remover part #891099 or equivalent.	Spray or wipe on, rub spots with soft cloth or sponge. Rinse and dry.

ALUMINUM EXTRUSIONS

- Cleaning aluminum extrusions should be performed after installation is completed to remove construction soil and accumulated environment soils and discoloration.
- Be cautious about using abrasive cleaning objects (scouring powders, steel wool, abrasive polishes, etc.) as they may scratch the surface; anodized aluminum surfaces will be permanently damaged.
- It is important to remove promptly cleaner run-down on uncleaned surfaces to avoid staining. For best results, use a micro-fiber cloth.
- Recommended cleaning product for aluminum extrusions: **3M Stainless Steel Cleaner and Polish (Aerosol)**.

ROUTINE INSPECTION

Facilities maintenance personnel, should establish a care and maintenance procedure for all members responsible for regular cleaning and maintenance which should include a visual inspection. Restrooms with heavy traffic, will contribute to wear and tear of the product.











To prevent cubicles from getting damaged or personal injury, here are some typical wear and tear and possible vandalism items that should be visually inspected by facilities maintenance personnel.

- Loose and missing screws
- Missing hardware
- Lubricate top door pivot and cam
- Loose speed nut in headrail
- Misalignment of cubicle
- Door latch not functioning

TROUBLESHOOTING GUIDE

ISSUE	POSSIBLE CAUSE	CORRECTIVE ACTION
Loose screws	Wear and tear due to heavy use.	Use T-25 bit and tighten loose screws. Make sure not to over-torque as it may break off.
Flexing	Loose screws on foot pedestal	Slide escutcheon up and tighten screws on floor. Use a 4mm hex bit, tighten through bolt on pedestal U-bracket.
Loose latch	Wear and tear due to heavy use.	Remove screws from latch assembly, add Loctite Thread Locker to each screws tip, and re-secure screws to latch assembly.

REPLACEMENT PARTS LIST

Part	Part #	Part Description	Application
	2000094	Pin-In-Head Torx Screw, #12 X 3"	Securing wall extrusion to wall.
	2000121	Pin-In-Head Torx Screw, #12 X 1-1/4"	Securing extrusion to another extrusion.
	2000128	Fascia Through-Bolt Screw Packet	Securing headrail L-bracket to headrail. Securing wall extrusion mounted on panel.
	2000074	Lock End Tip	Plastic end tip for latch handle.
	2000078	Coat Hook Partition Fix	Divider panel or door installation.
	2000080	Coat Hook Wall Fix	Wall installation.
	2000083	Door Buffer, Inswing	Door stops for inswing keeping extrusion.
	2000084	Door Buffer, Outswing	Door stops for outswing keeping extrusion.
	2000138	Headrail End Cap Pkt, Right	Headrail end cap.
	2000139	Headrail End Cap Pkt, Left	Headrail end cap.

PRODUCT WARRANTY AND LIMITATIONS

WARRANTY

Evolve panels, doors, and fascia panels are warranted against breakage, corrosion, and defects in workmanship from the date of purchase for the periods set forth (this limited warranty is conditioned on the toilet partitions being properly installed, used and serviced). **10-Year Warranty.**

Evolve hardware and mounting extrusions are guaranteed to be free from defects in material and workmanship for a period of **1-year Warranty** from date of purchase. Any products returned to Bobrick under this guarantee will be repaired or replaced at no charge.

LIMITATION ON WARRANTY

In all instances, the purchaser's exclusive remedy against Bobrick is for the repair or replacements, at Bobrick's option, of warranted defective products or parts. Bobrick will also bear the cost of the purchaser's return of defective products or parts to Bobrick.

Bobrick's warranty set forth above does not cover damage from vandalism. No other remedy (including, but not limited to, damages for field labor charges, lost profits, lost sales, injury to persons or property or any other incidental or consequential losses) is available.

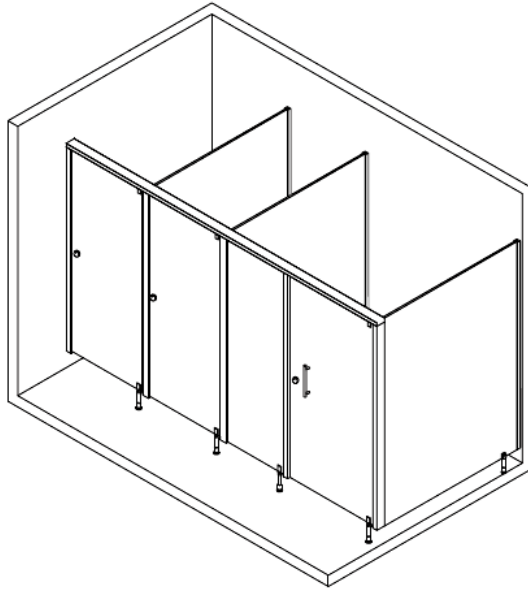

BUILDING VALUE SINCE 1906

In the U.S.A.: BOBRICK WASHROOM EQUIPMENT, INC.

Los Angeles: 6901 Tujunga Ave., North Hollywood, CA 91605-6213; Tel: (818) 982-9600, Fax: (818) 503-1102

New York: 200 Commerce Drive, Clifton Park, NY 12065-1350; Tel: (518) 877-7444, Fax: (518) 877-5029,
or e-mail: customerservice@bobrick.com

In Canada: BOBRICK WASHROOM EQUIPMENT COMPANY

45 Rolark Drive, Scarborough, Ontario M1R 3B1

Eastern Canada Tel: (877) 423-6555, Fax: 877-423-8555; Western Canada Tel: (877) 423-6444, Fax: 877-423-8444,
or e-mail customerservice@bobrick.com

2000000-69_ii - 1 ea.

